



FAUCETS

BY ROCELL



We've captured functionality in a work of art.

Go beyond the ordinary and into an extraordinary realm of elegance. So much more than functional beauty, Rocell faucets are created for precise performance with the superior function of water-saving, through an unequivocal craftsmanship that is of the highest international standards. Rocell offers you six distinctly unique collections to choose what best expresses your lifestyle. These masterpieces are designed to such beautiful perfection, they will transform your bathroom into a work of art, instantly.



FLAWLESS PERFECTION

Designed by world-renowned experts for superior performance. Chrome plated finish for matchless beauty.



QUICK-FIX

Designed through cutting-edge technology for surprisingly quick and easy installation.



WATER PROTECT

An environment-friendly product that saves water while providing optimum performance.



FREE-FLOW

The use of premium aerators and ceramic cartridges ensures a smooth flow of water.



QUALITY ASSURED

The promise of matchless quality and long-lasting durability

ALANTO



ALANTO

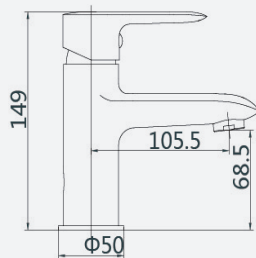

SINGLE LEVER BASIN MIXER

Ceramic cartridge insert Ø35mm

Code SD90943

(RB.TRC.0FA110.CB.PA)

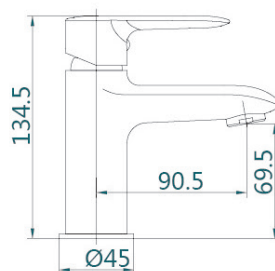

SINGLE LEVER COLD WATER TAP

Ceramic cartridge insert Ø35mm

Code SD90943L

(RB.TRC.0FA410.CB.PA)

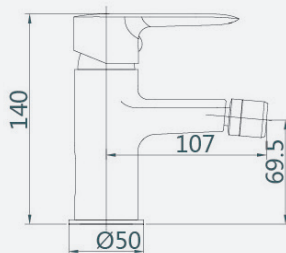

SINGLE LEVER BIDET MIXER

Ceramic cartridge insert Ø35mm

Code SD90944

(RB.TRC.0FA200.CB.PA)

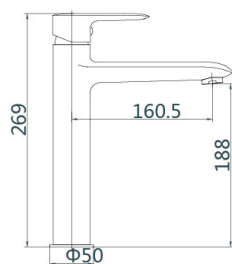

SINGLE LEVER HIGH SPOUT BASIN MIXER

Ceramic cartridge insert Ø35mm

Code SD 90943A

(RB.TRC.0FA120.CB.PC)

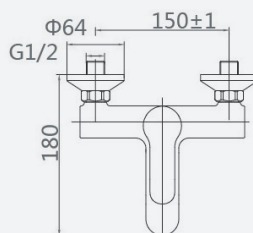
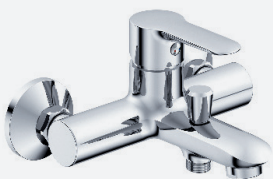

EXPOSED BATH MIXER

Ceramic cartridge insert Ø35mm

Code SD90941

(RB.TRC.0BS330.CB.PC)

ALANTO

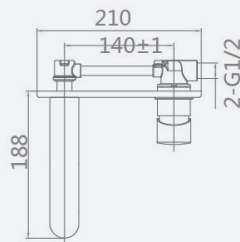
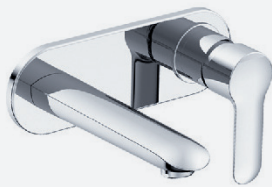

WALL MOUNTED BASIN MIXER

Ceramic cartridge insert Ø35mm

Code SD90943R

(RB.TRC.0FA130.CB.PA)

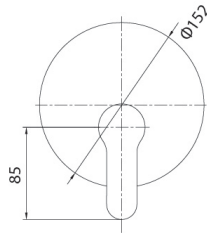

SINGLE LEVER CONCEALED SHOWER MIXER

Ceramic cartridge insert Ø35mm

Code SD90947RB

(RB.TRC.0FA320.CB.PB)

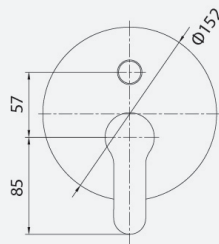

SINGLE LEVER CONCEALED BATH AND SHOWER MIXER

Ceramic cartridge insert Ø35mm

Code SD90941RB

(RB.TRC.0BS330.CB.PD)

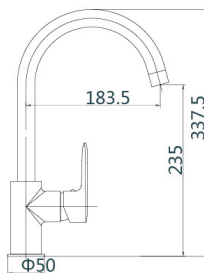

SINGLE LEVER SWAN NECK MIXER

Ceramic cartridge insert Ø35mm

Code SD 90945A

(RB.TRC.0FA120.CB.PD)

AQUARO



AQUARO

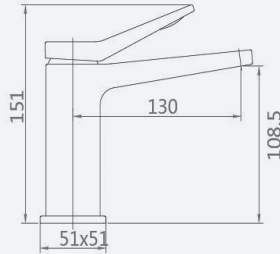

SINGLE LEVER BASIN MIXER

Ceramic cartridge insert Ø35mm

Code SD91293A-2

(RB.TRC.0FA110.CB.PC)

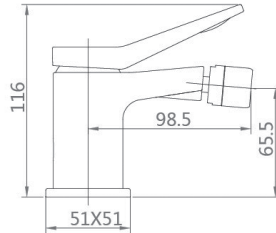

SINGLE LEVER BIDET MIXER

Ceramic cartridge insert Ø35mm

Code SD91294

(RB.TRC.0FA200.CB.PD)

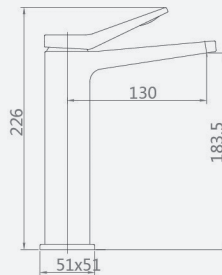

SINGLE LEVER HIGH SPOUT BASIN MIXER

Ceramic cartridge insert Ø35mm

Code SD91293A

(RB.TRC.0FA120.CB.PH)

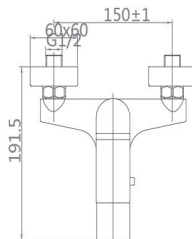

EXPOSED BATH MIXER

Ceramic cartridge insert Ø35mm

Code SD91291

(RB.TRC.0BS330.CB.PI)

AQUARO

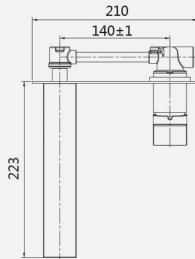

WALL MOUNTED BASIN MIXER

Ceramic cartridge insert Ø35mm

Code SD91293R

(RB.TRC.0FA130.CB.PD)

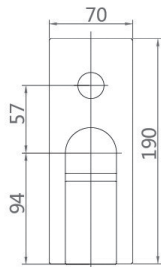

SINGLE LEVER CONCEALED SHOWER MIXER

Ceramic cartridge insert Ø35mm

Code SD91297RB

(RB.TRC.0FA320.CB.PE)

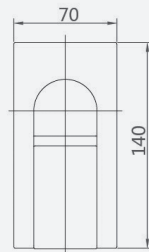

SINGLE LEVER CONCEALED BATH AND SHOWER MIXER

Ceramic cartridge insert Ø35mm

Code SD91291RB

(RB.TRC.0BS330.CB.PJ)

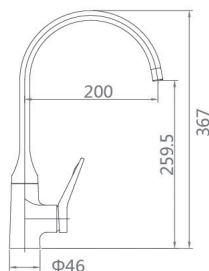

SINGLE LEVER SWAN NECK MIXER

Ceramic cartridge insert Ø35mm

Code SD91295-2

(RB.TRC.0FA120.CB.PI)



FORTE

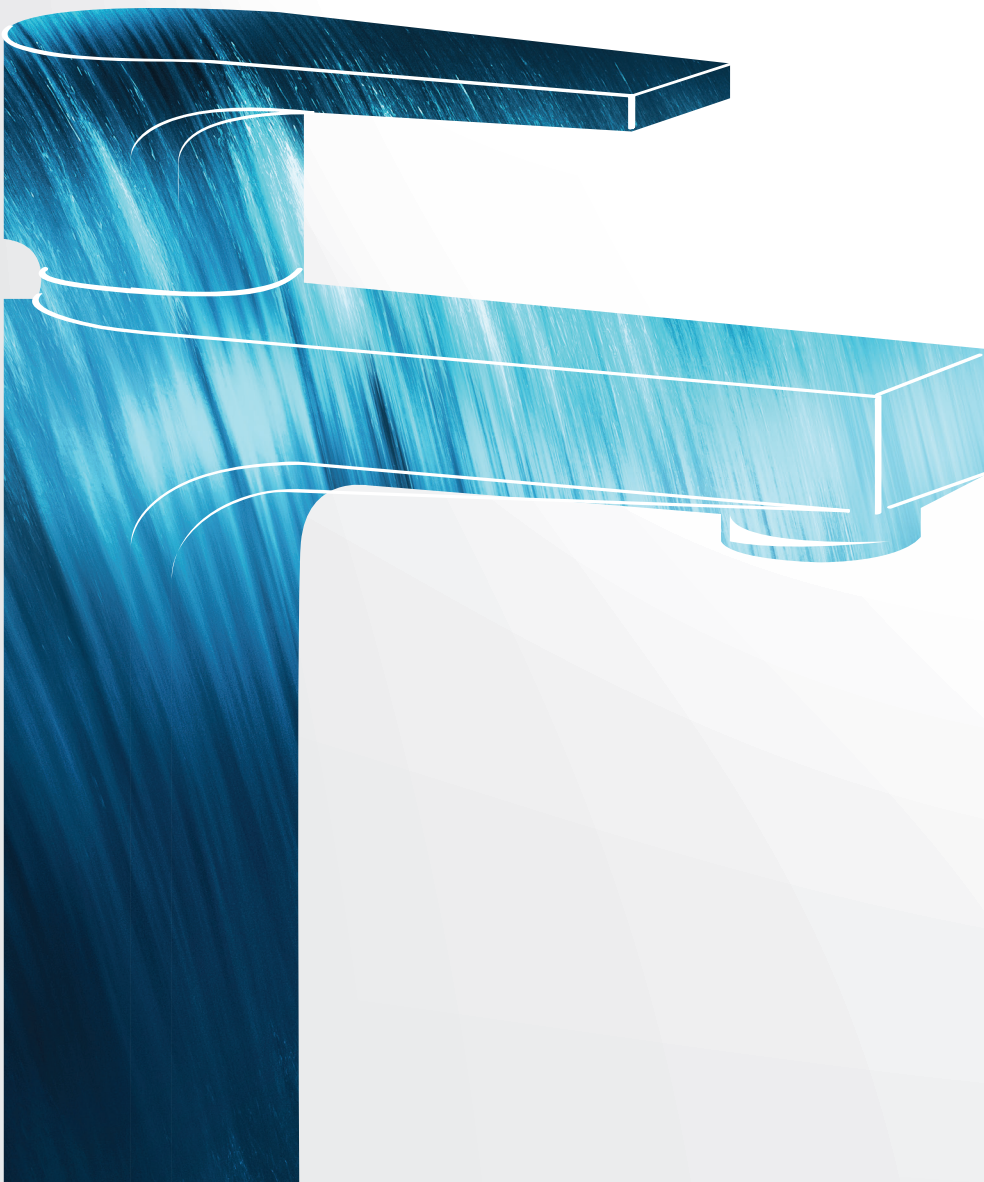

FORTE

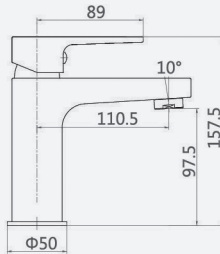

SINGLE LEVER BASIN MIXER

Ceramic cartridge insert $\Phi 35$ mm

Code SD90893

(RB.TRC.0FA110.CB.PF)

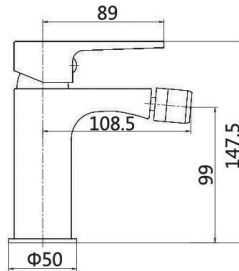

SINGLE LEVER BIDET MIXER

Ceramic cartridge insert $\Phi 35$ mm

Code SD90894

(RB.TRC.0FA200.CB.PE)

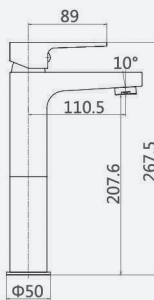

SINGLE LEVER HIGH SPOUT BASIN MIXER

Ceramic cartridge insert $\Phi 35$ mm

Code SD90893A

(RB.TRC.0FA120.CB.PA)

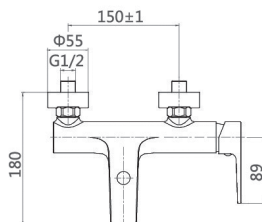

EXPPOSED BATH MIXER

Ceramic cartridge insert $\Phi 35$ mm

Code SD90891

(RB.TRC.0BS330.CB.PA)

FORTE

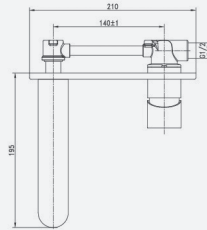

WALL MOUNTED BASIN MIXER

Ceramic cartridge insert Ø35mm

Code SD90713R

(RB.TRC.0FA130.CB.PE)

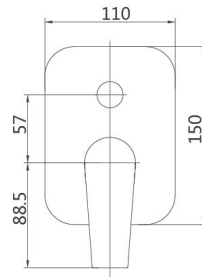

SINGLE LEVER CONCEALED SHOWER MIXER

Ceramic cartridge insert Ø35mm

Code SD90897RB

(RB.TRC.0BS330.CB.PB)

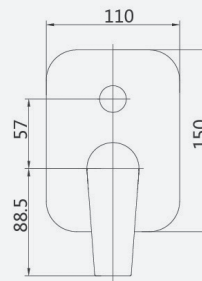

SINGLE LEVER CONCEALED BATH AND SHOWER MIXER

Ceramic cartridge insert Ø35mm

Code SD90891RB

(RB.TRC.0FA320.CB.PA)

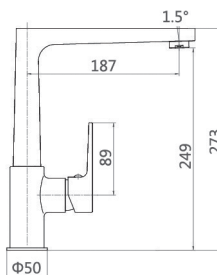

SINGLE LEVER SWAN NECK MIXER

Ceramic cartridge insert Ø35mm

Code SD90895

(RB.TRC.0FA120.CB.PB)

LOOP

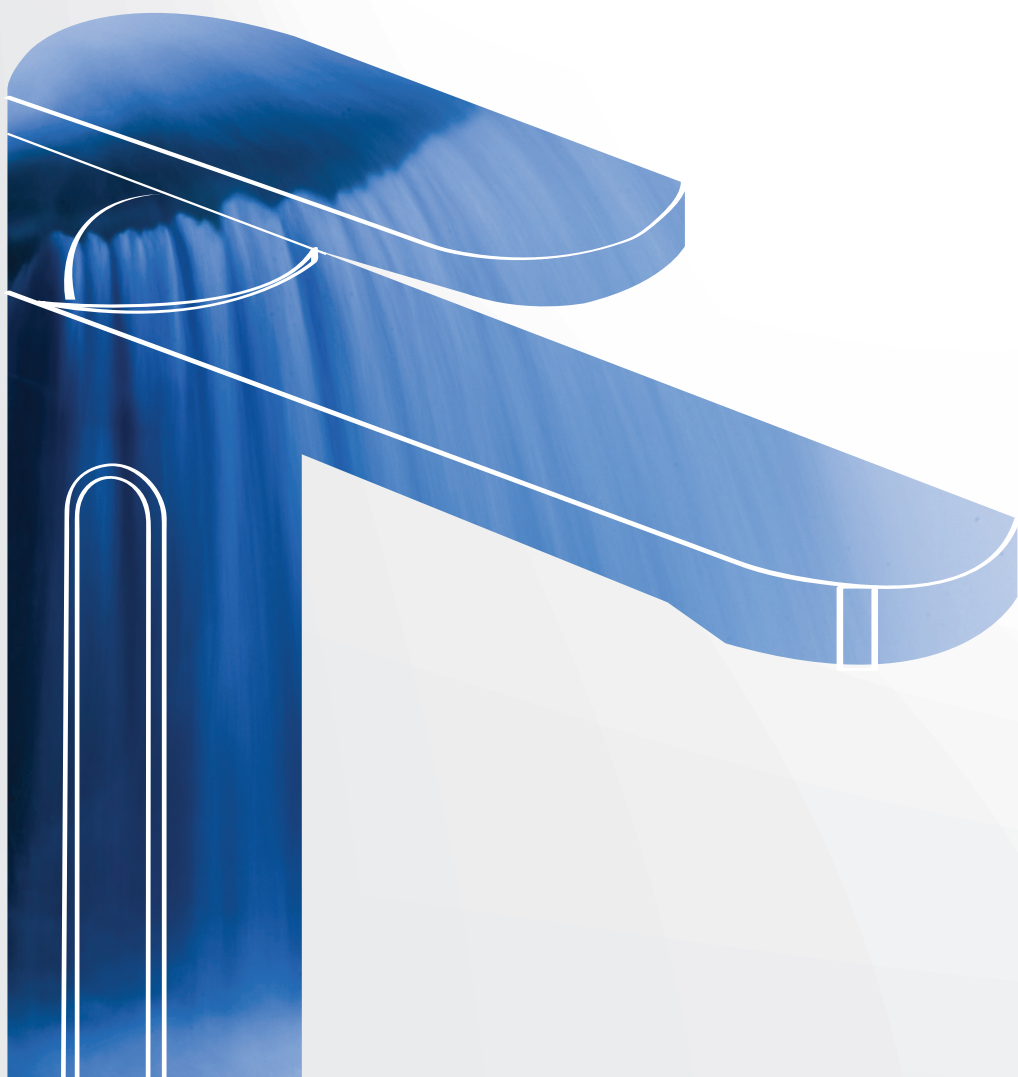

LOOP

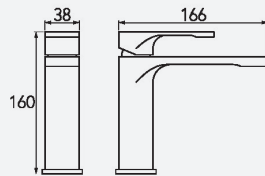

SINGLE LEVER BASIN MIXER

Ceramic cartridge insert Ø25mm

Code I-FL0001

(RB.TRC.0FA110.CB.PH)

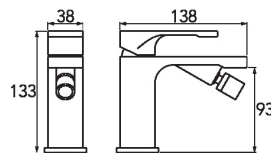

SINGLE LEVER BIDET MIXER

Ceramic cartridge insert Ø35mm

Code I-FL0007

(RB.TRC.0FA200.CB.PF)

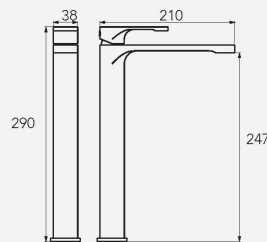

SINGLE LEVER HIGH SPOUT BASIN MIXER

Ceramic cartridge insert Ø25mm

Code I-FL0005

(RB.TRC.0FA200.CB.PJ)

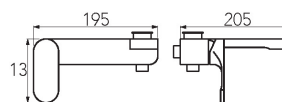

EXPOSED BATH MIXER WITH HAND SHOWER

Ceramic cartridge insert Ø25mm

Code I-FL0018

(RB.TRC.OBS330.CB.PK)

LOOP

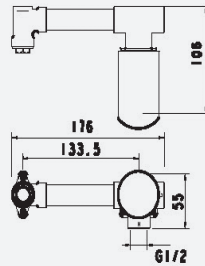

CONCEALED BODY FOR WALL MOUNTED BASIN MIXER

Ceramic cartridge insert Ø25mm

Code IDC-F0246

(RB.TRC.0FA130.CB.PJ)

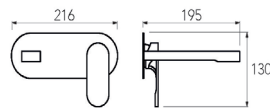

WALL MOUNTED BASIN MIXER

Ceramic cartridge insert Ø35mm

Code I-FL0031-1

(RB.TRC.0FA130.CB.PF)

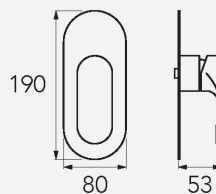

SINGEL LEVER CONCEALED SHOWER MIXER

Ceramic cartridge insert Ø35mm

Code I-FL0024

(RB.TRC.0FA320.CB.PK)

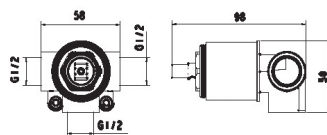

CONCEALED BODY FOR SINGEL LEVER SHOWER MIXER

Ceramic cartridge insert Ø35mm

Code IDC-F0248

(RB.TRC.0FA320.CB.PL)

LOOP

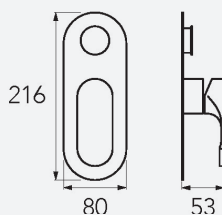

SINGEL LEVER CONCEALED BATH AND SHOWER MIXER

Ceramic cartridge insert Ø35mm

Code I-FL0022-1

(RB.TRC.0BS330.CB.PL)

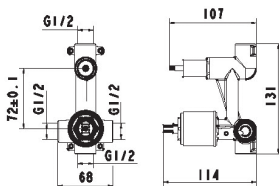

CONCEALED BODY FOR SINGEL LEVER BATH AND SHOWER MIXER

Ceramic cartridge insert Ø35mm

Code I-FL0001

(RB.TRC.0FA330.CB.PA)

SPRINT



SPRINT

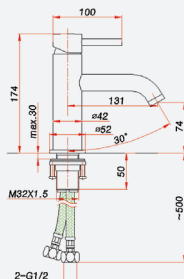

SINGLE LEVER BASIN MIXER

Ceramic cartridge insert Ø35mm

Code M020105/043130

(RB.TAB.0FA110.CB.PI)

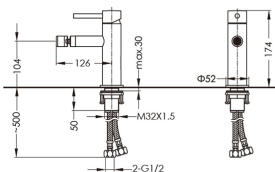

SINGLE LEVER BIDET MIXER

Ceramic cartridge insert Ø35mm

Code M020107/043120

(RB.TAB.0FA200.CA.PG)

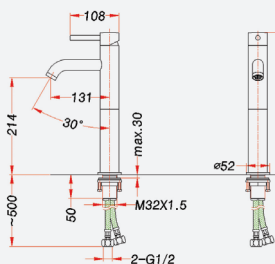

SINGLE LEVER HIGH SPOUT BASIN MIXER

Ceramic cartridge insert Ø35mm

Code M020106/043140

(RB.TAB.0FA110.CB.PJ)

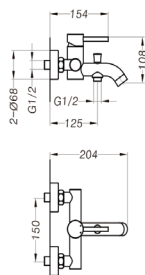

EXPOSED BATH MIXER WITH HAND SHOWER

Ceramic cartridge insert Ø35mm

Code 82840

(RB.TAB.0FA330.CB.PI)

SPRINT

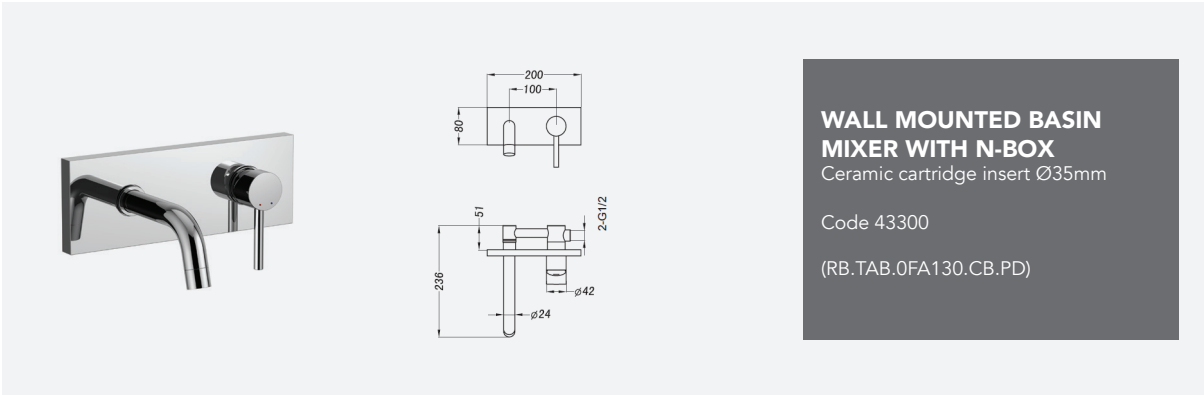

WALL MOUNTED BASIN MIXER WITH N-BOX

Ceramic cartridge insert Ø35mm

Code 43300

(RB.TAB.0FA130.CB.PD)

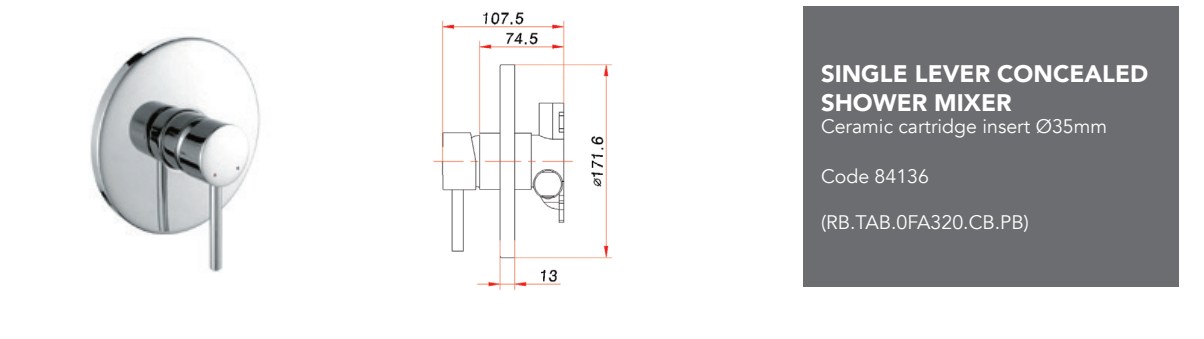

SINGLE LEVER CONCEALED SHOWER MIXER

Ceramic cartridge insert Ø35mm

Code 84136

(RB.TAB.0FA320.CB.PB)

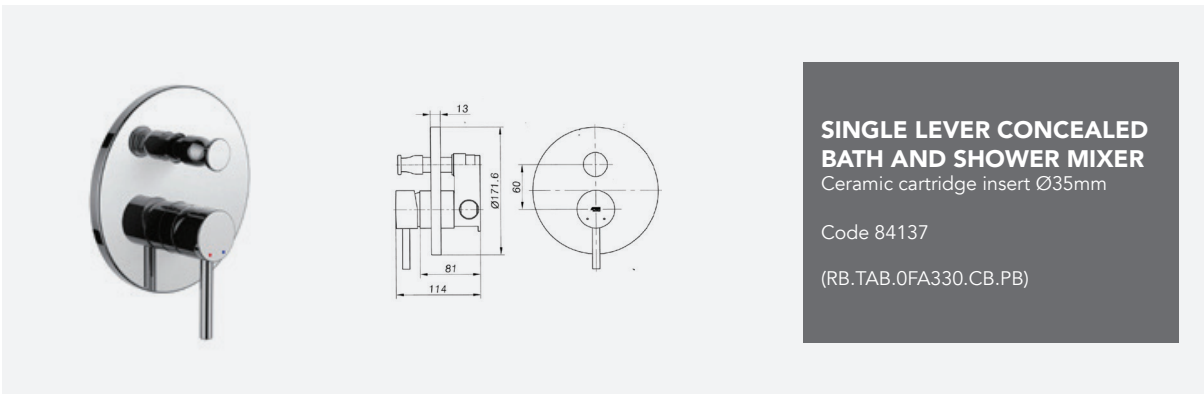

SINGLE LEVER CONCEALED BATH AND SHOWER MIXER

Ceramic cartridge insert Ø35mm

Code 84137

(RB.TAB.0FA330.CB.PB)



RECESSED LIGHTING

RECESSED LIGHTING

RECESSED LIGHTING

RECESSED LIGHTING

RECESSED LIGHTING

RECESSED LIGHTING

RECESSED LIGHTING

RECESSED LIGHTING

RECESSED LIGHTING

RECESSED LIGHTING

RECESSED LIGHTING

RECESSED LIGHTING

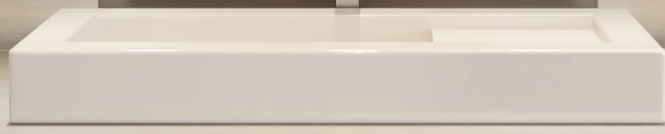

VERO



VERO

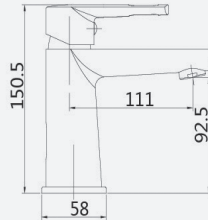

SINGLE LEVER BASIN MIXER

Ceramic cartridge insert Ø35mm

Code SD91223

(RB.TRC.0FA110.CB.PE)

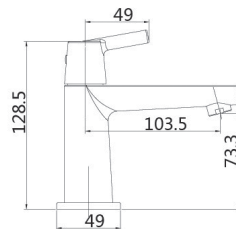

SINGLE LEVER COLD WATER TAP

Ceramic cartridge insert Ø35mm

Code SD91223L

(RB.TRC.0FA410.CB.PE)

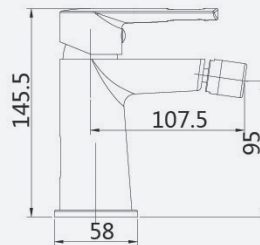

SINGLE LEVER BIDET MIXER

Ceramic cartridge insert Ø35mm

Cod. SD91224

(RB.TRC.0FA200.CB.PE)

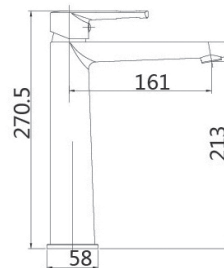

SINGLE LEVER HIGH SPOUT BASIN MIXER

Ceramic cartridge insert Ø35mm

Code SD91223A

(RB.TRC.0FA120.CB.PE)

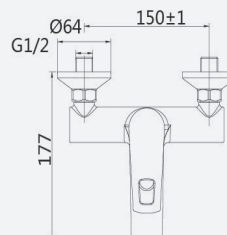
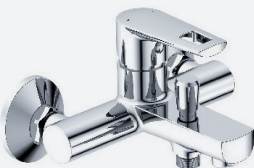

EXPOSED BATH MIXER

Ceramic cartridge insert Ø35mm

Code SD91221

(RB.TAB.0BS330.CB.PE)

VERO

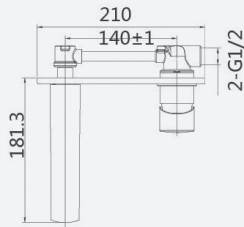
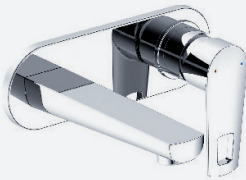

WALL MOUNTED BASIN MIXER

Ceramic cartridge insert Ø35mm

Cod. SD91223R

(RB.TRC.0FA130.CB.PB)

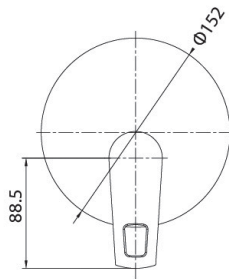

SINGLE LEVER CONCEALED SHOWER MIXER

Ceramic cartridge insert Ø35mm

Code SD91227RB

(RB.TRC.0FA320.CB.PC)

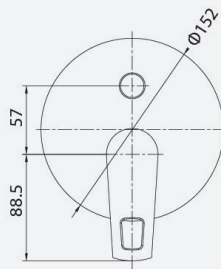

SINGLE LEVER CONCEALED BATH AND SHOWER MIXER

Ceramic cartridge insert Ø35mm

Code SD91221RB

(RB.TRC.0BS330.CB.PF)

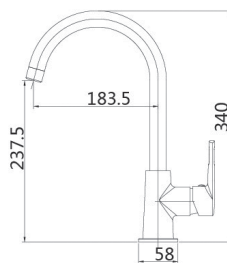

SINGLE LEVER SWAN NECK MIXER

Ceramic cartridge insert Ø35mm

Code SD91225

(RB.TRC.0FA120.CB.PF)

COLD WATER TAP



COLD WATER TAPS

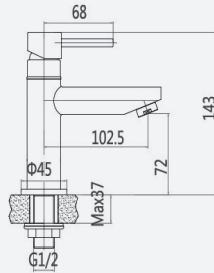

COLD WATER TAP

Ceramic cartridge insert $\varnothing 25\text{mm}$

Code SD9A033

(RB.TRC.0FA320.CB.PF)

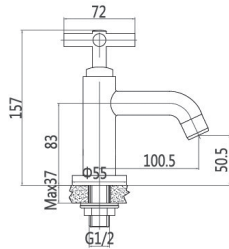

COLD WATER TAP

Ceramic cartridge insert $\varnothing G\frac{1}{2}$

Code SD9A053

(RB.TRC.0FA320.CB.PH)

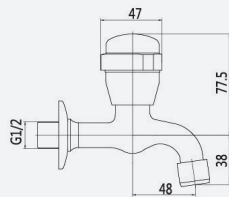

COLD WATER BIB TAP

Ceramic cartridge insert $\varnothing G\frac{1}{2}$

Code SD9A126

(RB.TRC.0FA320.CB.PG)

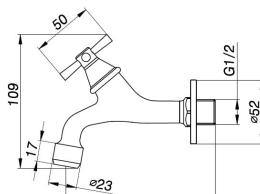

COLD WATER BIB TAP

Ceramic cartridge insert $\varnothing G\frac{1}{2}$

Code Z071001/001850

(RB.TAB.0FA420.CB.PA)

COLD WATER TAPS

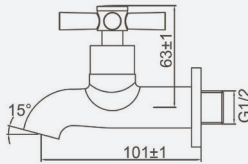

COLD WATER BIB TAP
Ceramic cartridge insert $\text{Ø}G1/2$

Code 013470

(RB.TAB.0FA420.CB.PE)

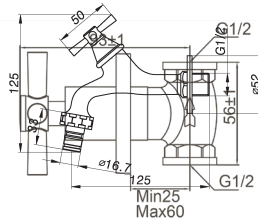

GARDEN TAP
Ceramic cartridge insert $\text{Ø}G1/2$

Code 011860

(RB.TAB.0FA430.CB.PA)

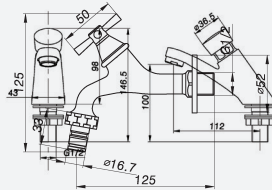

COLD WATER SELF-CLOSING TAP
Ceramic cartridge insert $\text{Ø}M 27 \times 1.5$

Code N090043

(RB.TAB.0FA410.CB.PK)

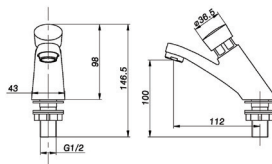

COLD WATER SELF-CLOSING TAP
Ceramic cartridge insert $\text{Ø}M 27 \times 1.5$

Code N090043

(RB.TAB.0FA410.CB.PK)

SENSOR MIXER



SENSOR MIXERS

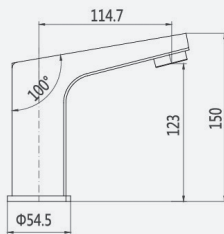

COLD WATER SENSOR TAP

Code SD9B113

(RB.TRC.0FA600.CB.PA)

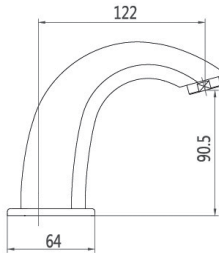

COLD WATER SENSOR TAP

Code SD9B033

(RB.TRC.0FA600.CB.PB)



KITCHEN MIXER



KITCHEN MIXERS

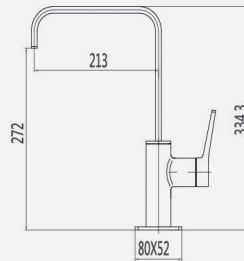

SINGLE LEVER KITCHEN MIXER

Ceramic cartridge insert Ø35mm

Code SD61405

(RB.TRC.0KA200.CB.PB)

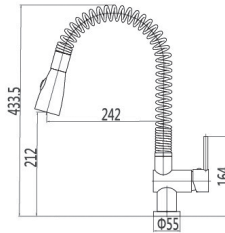

SINGLE LEVER KITCHEN MIXER

Ceramic cartridge insert Ø35mm

Code SD61475

(RB.TRC.0KA200.CB.PA)

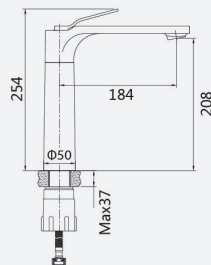

SINGLE LEVER KITCHEN MIXER

Ceramic cartridge insert Ø35mm

Code SD61645

(RB.TRC.0KA200.CB.PC)

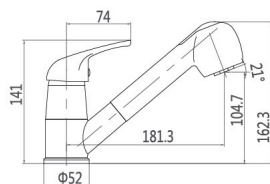

SINGLE LEVER KITCHEN MIXER

Ceramic cartridge insert Ø35mm

Code SD90048-2

(RB.TRC.0KA200.CB.PD)

KITCHEN MIXERS

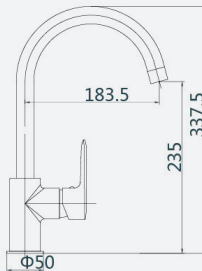

SINGLE LEVER SWAN NECK MIXER

Ceramic cartridge insert $\text{\O}35\text{mm}$

Code SD90945

(RB.TRC.0FA120.CB.PD)

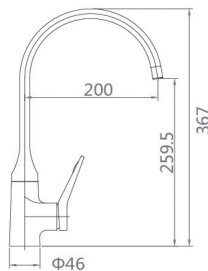

SINGLE LEVER SWAN NECK MIXER

Ceramic cartridge insert $\text{\O}35\text{mm}$

Code SD91295-2

(RB.TRC.0FA120.CB.PI)

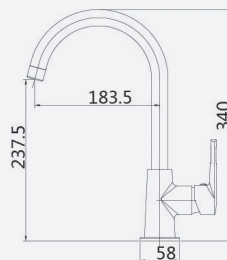

SINGLE LEVER SWAN NECK MIXER

Ceramic cartridge insert $\text{\O}35\text{mm}$

Code SD91225

(RB.TRC.0FA120.CB.PF)

FLOOR STANDING



FLOOR STANDING

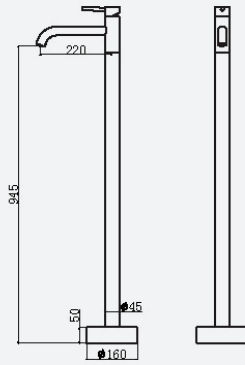

FLOOR-STANDING BASIN MIXER

Ceramic cartridge insert $\varnothing 35\text{mm}$

Code IDC-F0196

(RB.TRC.0FA340.CB.PA)

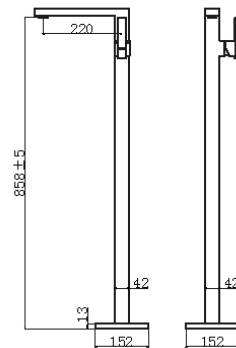

FLOOR-STANDING BATH TUB MIXER

Ceramic cartridge insert $\varnothing 40\text{mm}$

Code IDC-F0200

(RB.TRC.0FA340.CB.PB)

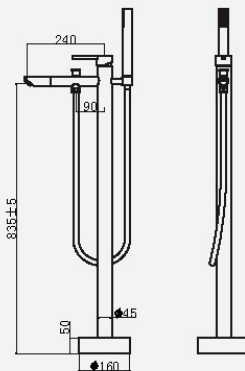

FLOOR-STANDING BATH TUB MIXER

Ceramic cartridge insert $\varnothing 40\text{mm}$

Code IDC-F0212

(RB.TRC.0FA340.CB.PC)



CORPORATE OFFICE – 20, R. A. De Mel Mawatha, Colombo 03, Sri Lanka.
T : 011 7762862, 076 9986129 E : info@rcl.lk

 Rocell  rocelsrilanka